

# DEVELOPMENT OF HIGH QUALITY ACOUSTIC SUBBAND ECHO CANCELLER USING DUAL-FILTER STRUCTURE AND FAST RECURSIVE LEAST SQUARES ALGORITHM

*Youhua Wang* † *Yasuhiro Terada* † *Minoru Matsui* † *Kazuhiro Iida* ‡ *Kenji Nakayama*

Matsushita Communication Kanazawa R&D Labs. Co., Ltd.

†AVC Research Lab., Matsushita Communication Industrial Co., Ltd.

‡Faculty of Engineering, Kanazawa University

## ABSTRACT

A high quality acoustic subband echo canceller is developed based on a dual-filter structure and the fast recursive least squares (FRLS) algorithm. Methods for overcoming the instability problem of the FRLS algorithm and implementing it using the 32-bit fixed-point arithmetic are presented. A new tap-weight transfer method, which assures double talk detection, is proposed. Computer simulations demonstrate that fast convergence and fast tracking are achieved in an acoustic subband echo canceller using 32 subbands and a total of 4000-tap FIR filter for a 250ms echo path. The combined use of the FRLS algorithm in the lowest eight frequency bands and the normalized least mean square (NLMS) algorithm in the rest of the frequency bands increases convergence rate for speech signals by five to ten times, and the echo return loss enhancement (ERLE) by more than 10dB over those of using only the NLMS algorithm.

## 1. INTRODUCTION

Acoustic echo canceller has been a very active research field in the recent years, due to its variety of applications in communications, such as teleconference system and mobile phone system. According to the International Telecommunication Union (ITU)'s new echo canceller recommendation G.168, the key fundamental requirements that conform to this recommendation are those including (1) rapid convergence, (2) high ERLE and (3) assured double talk detection. In acoustic systems, the echo path is usually long and the number of taps in the adaptive filter is therefore large. Furthermore, the training signal is often narrowbanded like speech signal. This makes the convergence performance of the widely used NLMS algorithm hard to be satisfactory. The introduction of the FRLS algorithm, which can provide a fast convergence rate with a computational cost of  $O(7M)$  ( $M$  is the number of tap weights of adaptive filter), attracts many attentions during the past two decades [1]. The instability problem of this algorithm, however, greatly impairs its practical applications. In acoustic echo canceller application, a periodic reinitialization process for overcoming the instability problem was proposed [2]. However, the increase of the residual error along with the reinitialization degrades the ERLE performance. On the other hand, echo canceller using a dual-filter structure was proposed for solving the double talk detection problem [3]. The basic idea

of this method is to form a foreground and a background echo models. Only the background model is adapted and its result is transferred to the foreground model whenever the residual echo produced by the background model is smaller. The problem of this method is that during double talk period, a smaller residual echo model does not mean that the error of the tap-weight vector or the error of the echo replica is also smaller. Mistransferring of the tap weights may occur especially when the far-end and the near-end signals are speech [3][4].

In this paper, a high quality acoustic echo cancellation system is presented. Fast convergence rate and fast tracking speed are achieved by using the FRLS algorithm. The discontinuous problem produced by periodic reinitialization process is overcome by employing the dual-filter structure. Assured double talk detection is realized by using a set of new tap-weight transfer conditions. Computational load is reduced by introducing subband filters. Further reduction of computation is achieved by using the FRLS algorithm only in the lower frequency bands in which the most part of the echo power is concentrated, and the NLMS algorithm in the higher frequency bands. The implementation of the FRLS algorithm using the 32-bit fixed-point arithmetic is realized. Computer simulation results confirm the efficacy of the proposed structure and methods for an acoustic echo canceller using 32 subbands and a total of 4000-tap FIR filter for a 250ms echo path.

## 2. NEW TAP-WEIGHT TRANSFER METHOD

### 2.1. Dual-filter based echo canceller

The structure of the dual-filter based echo canceller is shown in Fig.1. The tap weights of the adaptive filter (AF) are trained during the non-double talk period and transferred to the filter (F) after convergence. During the double talk period, the tap weights of the AF are misadjusted, so it is necessary to prevent the transfer by employing some control conditions. This is not an easy problem when a slow convergence algorithm, such as the NLMS algorithm, is used. If the transfer conditions are set too severe, then it is not possible to transfer the tap weights at an appropriate time and therefore reduce the tracking speed. On the other hand, if the transfer conditions are too loose, then the transfer may happen during the double talk period. How to distinguish between the double talk and the echo path change is

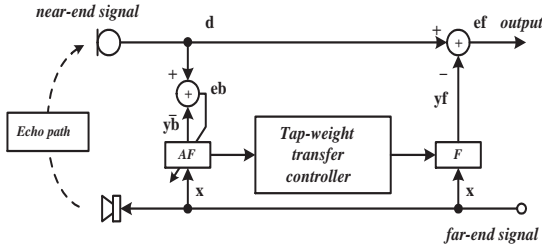

Figure 1: Dual-filter-based echo canceller

another problem of the conventional NLMS method.

## 2.2. New tap-weight transfer method

The proposed new tap-weight transfer method is based on the use of the FRLS algorithm. For this algorithm, it is known that the convergence is achieved after a fixed number of iterations, which means that the convergence is independent of the property of the input signal. By employing this characteristic of the FRLS algorithm, a new tap-weight transfer method is proposed. As shown in Fig.2, period K indicates the necessary iterations needed for the FRLS algorithm to converge. Period L is used for computing the mean squared errors (MSE) and the correlation between the real echo and its replica. If there is no double talk in period K, then the tap weights are converged and possible to be transferred in period L. During the double talk period, the FRLS algorithm will not converge in K iterations and the MSE can not be reduced in period L. So some thresholds can be designed to judge whether the tap weights should be transferred or not. It has been proved that the iterations for convergence of the FRLS algorithm is about  $2M \sim 3M$  [4][5]. Since the convergence is fast and assured, distinguishing between the double talk and the echo path change becomes easy and setting severe tap-weight transfer conditions is possible.

Based on the above discussions, the following tap-weight transfer conditions are given.  $\alpha$ ,  $\beta$  and  $\gamma$  indicate the thresholds.

- Condition 1:  $\sum e_b^2 \leq \alpha \sum e_f^2$

This gives the necessary condition which means that the MSE of the AF should be smaller than that of the F.

- Condition 2:  $\beta_1 \leq \frac{\sum |y_b \cdot d|}{\sum y_b^2} \leq \beta_2$

This condition is to detect the deviation between the correlation of the real echo and its replica. The deviation is increased during the double talk period or when the echo path changes. By using this condition, the double talk detection is assured with a high precision.

- Condition 3:  $\sum y_b^2 \geq \gamma \sum e_b^2$

This is to prevent the tap-weight transfer during the period in which the power of the far-end signal is too small. For speech signal input, the signal is discontinuous. It is possible that the training period K may

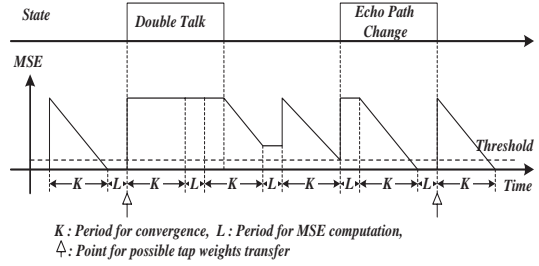

Figure 2: Proposed tap-weight transfer method

not be sufficient for convergence. Nevertheless, during the following period L, the above two conditions may be satisfied and the tap weights are transferred if the power of the input signal is too small.

By using the FRLS algorithm and the conditions 1 ~ 3 simultaneously, a quick and correct tap-weight transfer can be realized.

## 3. APPLICATION TO ACOUSTIC ECHO CANCELLER

### 3.1. Instability problem of the FRLS algorithm

The instability is an inherent problem of the FRLS algorithm. In applying the proposed method to an acoustic echo canceller, two methods are adopted for overcoming this problem. One method is to use the periodic reinitialization process. The other is to use the subband filters that can decrease the number of the tap weights in each band and therefore prolong the stability performance.

### 3.2. Computational complexity reduction

It is known that an effective method for computational complexity reduction is to employ the subband method [6][7]. In acoustic echo canceller applications, further reduction is achieved by using the FRLS algorithm only in the lower frequency bands in which the most part of the echo energy is concentrated. The NLMS algorithm may be used in the rest of the bands. Since the convergence time of using the NLMS algorithm is not sure, condition 2 is difficult to be used for judging whether an increase of the MSE is due to the echo path change (the tap weights should be transferred) or due to the double talk (the tap weights should not be transferred). To solve this difficulty, the structure shown in Fig.3 is employed. In the bands of using the NLMS algorithms, the tap-weight transfer is judged based on condition 1 and 3 as well as condition 2 that is given from the bands of using the FRLS algorithms.

## 4. SIMULATION RESULT

### 4.1. Simulation conditions

The computer simulations are carried out based on the structure shown in Fig.3. The FRLS algorithm is implemented by using the 32-bit fixed-point arithmetic. The other parts of the simulations are done by using the 32-bit floating-point arithmetic. For performance comparisons,

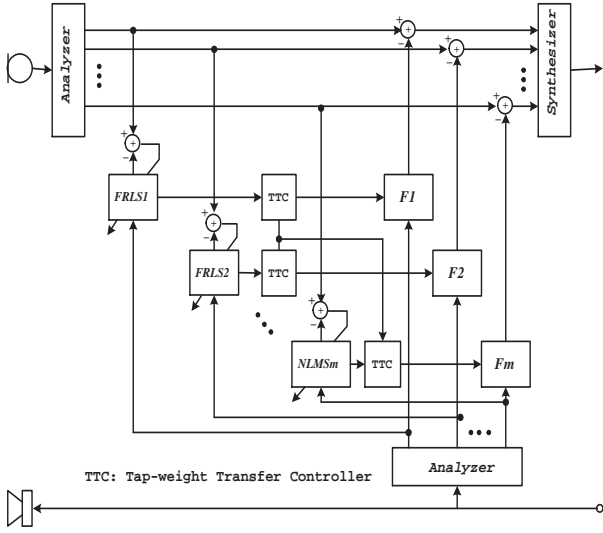

Figure 3: Structure used for acoustic echo canceller.

simulations on the conventional NLMS method are also carried out.

The echo path is obtained from a room environment. The distance between the microphone and the loud-speaker is three meters. Figure 4 shows the impulse response of the echo path. The echo path change is realized by left-shifting the original one by 10 samples.

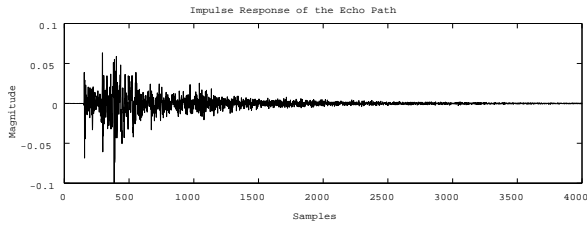

Figure 4: Impulse response of the echo path

In the proposed method, the FRLS algorithms are used in the lowest eight subbands and the NLMS algorithms are used in the rest of the bands. The initial parameter  $\delta = 0.01$  and the forgetting factor  $\lambda = 0.99$  are used for the FRLS algorithm. The step size  $\mu = 0.5$  is used for the NLMS algorithm. The tap-weight transfer conditions 1 ~ 3 are used simultaneously with  $\alpha = 0.5$ ,  $\beta_1 = 0.8$  and  $\beta_2 = 1.2$ ,  $\gamma = 10$ . The period of reinitialization in the FRLS algorithm is  $4M$  ( $M$  is the number of the tap weights in the correspondent band).

In the conventional method, the NLMS algorithms are used in all of the bands. The step size  $\mu = 0.5$  is used for the NLMS algorithm. The tap-weight transfer condition 1 is used with  $\alpha = 0.5$ .

The other simulation conditions are as follows

- Sampling frequency:  $16kHz$
- Echo path length:  $250ms$

- Far-end signal: Male voice
- Near-end signal: Female voice
- Structure of subband filters: FIR-type DFT filter bank
- Number of subband: 32
- Number of down-sampling: 24

The number of tap weights in each band from  $0kHz$  to  $4kHz$  is 168 for a  $250ms$  acoustic tail length. The number of tap weights in each band from  $4kHz$  to  $7kHz$  is 100 for a  $150ms$  acoustic tail length.

#### 4.2. Fixed-point implementation of the FRLS algorithm

In the proposed acoustic echo canceller, the complex FRLS algorithm with computational load of  $O(7M)$  is adopted. In this algorithm, the error squares of both the forward and backward predictors  $F_M(n)$  and  $B_M(n)$  are needed and their initial values are assumed to be equivalent [1][5]. However, under a finite-precision implementation, the following initial value for  $B_M(n)$  can provide a more stable performance (the symbols are consistent with those in Ref.[5]).

$$B_M(0) = \frac{u(M+1)}{\lambda \tilde{k}_{M+1}^{M+1}(1)} \quad (1)$$

The derivation is based on the following relations

$$\psi_M(1) = \lambda B_M(0) \tilde{k}_{M+1}^{M+1}(1) = \mathbf{c}_{M+1}^H(0) \mathbf{u}_{M+1}(1) \quad (2)$$

To implement the FRLS algorithm using the 32-bit fixed-point arithmetic, attention should be paid to the overrange problem of the normalized gain vector  $\tilde{\mathbf{k}}_M(n)$ ,  $F_M(n)$  and  $B_M(n)$ .  $\tilde{\mathbf{k}}_M(n)$  may have a very large value when the inverse correlation matrix of the input is near singular. The input signal with a large eigenvalue spread, such as speech, also causes a large value ranges of  $\mathbf{k}_M(n)$ ,  $F_M(n)$  and  $B_M(n)$ . Therefore, normalization of the input signal in each band is necessary. The conversion factor  $\gamma_M(n)$  is used as a rescue variable for detecting the overflow of  $\tilde{\mathbf{k}}_M(n)$ . Tap-weight transfer is stopped and the FRLS algorithm is reset whenever the overflow is observed. As concerning to  $F_M(n)$  and  $B_M(n)$ , since both of them are scalars, a 32-bit floating-point arithmetic is used for simplicity.

Figure 5 shows the stability performance of the FRLS algorithm using the 32-bit fixed-point arithmetic. The simulation is done using the conditions as shown above. From the result, it can be seen that the instability does not appear until about 30,000 samples, which is equivalent to 1250 iterations in each band. This gives a sufficient stable performance for the reinitialization period of  $4M$  (672 iterations).

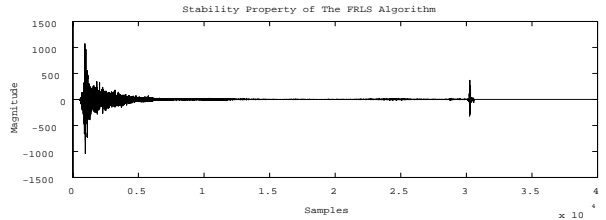

Figure 5: Stability performance of the FRLS algorithm.

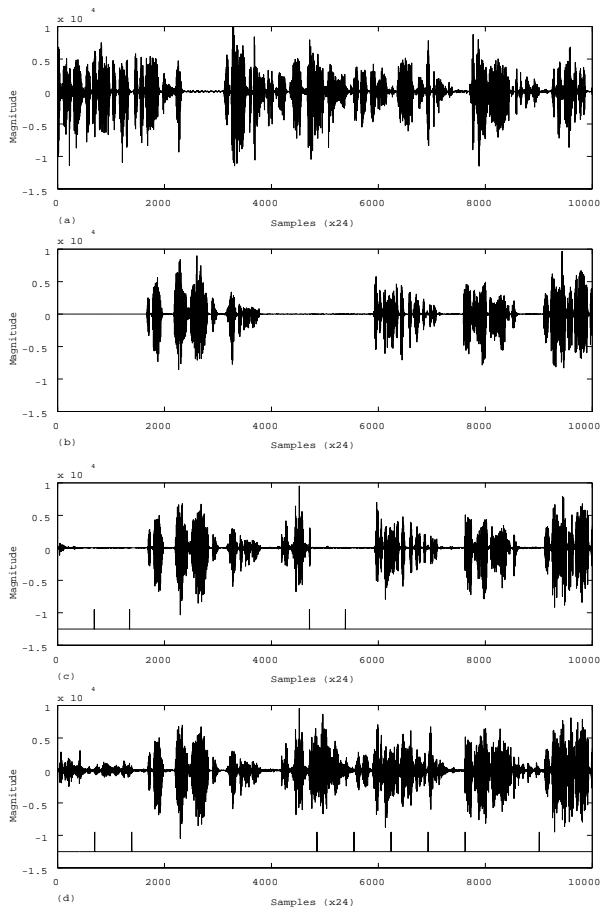

Figure 6: Simulation result (a) Far-end speaker signal; (b) Near-end speaker signal; (c) Residual error  $e_f$  and sampling points for tap-weight transfer by using the proposed method; (d) Residual error  $e_f$  and sampling points for tap-weight transfer by using the conventional NLMS method.

### 4.3. Simulation results

The simulation results are shown in Fig.6. The tracking ability is tested by a sudden change of the echo path at 4167 (10,000 samples). From these results, we can see that the proposed acoustic echo canceller has a very fast convergence rate and tracking speed compared with those of using only the NLMS algorithm. The tap-weight transfers occur at appropriate times. No transfers are observed during the double talk period in the simulations. On the other hand, in the case of using only the NLMS algorithm, it is difficult to give the conditions for a quick and correct tap-weight transfer.

Figure 7 shows the ERLE performance of the proposed and the conventional methods. It can be seen that the combined use of the FRLS algorithm in the lowest eight frequency bands and the NLMS algorithm in the rest of the frequency bands increases convergence rate for speech signals by five to ten times, and the ERLE by more than 10dB over those of using only the NLMS algorithm. A DSP-based 32-bit floating-point real time realization of the proposed acoustic echo canceller is completed. The performances are

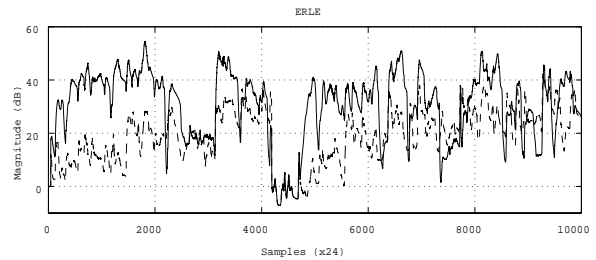

Figure 7: ERLE comparison of the proposed and the conventional methods (without the near-end speaker signal). Proposed method (solid line) and conventional method (dashed line).

consistent with the simulation results. Real time implementation of the proposed system using the fixed-point arithmetic is under development.

## 5. CONCLUSION

A high quality acoustic echo canceller is presented. Desirable performances on convergence rate and tracking speed are realized by employing the FRLS algorithm. A high reliable double talk detection is provided by using the dual-filter based structure and the proposed tap-weight transfer method. Computational complexity reduction has been realized by adopting the subband filters and using the FRLS algorithm only in the lower frequency bands. Computer simulations have demonstrated the efficacy of the proposed structure and methods. A real time DSP-based experiments have been implemented and the results are consistent with the computer simulations.

## 6. REFERENCES

- [1] J.M.Cioffi and T.Kailath, "Fast, recursive-least-squares transversal filters for adaptive filtering", *IEEE Trans. ASSP*, vol.ASSP-32, no.2, pp.304-337, 1984.
- [2] B. Hally, "Recursive least squares algorithms using multirate systems for cancellation of acoustical echoes", *Proc. ICASSP*, vol.2, pp.1145-1148, 1990.
- [3] K.Ochiai, et al., "Echo canceler with two echo path models", *IEEE Trans. Communications*, vol.COM-25, no.6, pp.589-595, 1977.
- [4] Y.Wang, K.Nakayama and Z.Ma, "A new structure for noise and echo cancelers based on a combined fast adaptive filter algorithm", *IEICE Trans. Fundamentals*, vol.E78-A, no.7, pp.845-853, 1995.
- [5] S.Haykin, *Adaptive Filter Theory*, Second Edition, Prentice-Hall, 1991.
- [6] H.Yasukawa and S.Shimada, "An acoustic echo canceller using subband sampling and decorrelation method", *IEEE Trans. Signal Processing*, vol.41, no.2, pp.926-930, 1993.
- [7] R.E.Crochiere and L.R.Rabiner, *Multirate Digital Signal Processing*, Prentice-Hall, 1983.