

A Combined Fast Adaptive Algorithm Applied to Noise Cancellation

Youhua Wang † Zhiqiang MA ‡ Kenji NAKAYAMA ‡

†Graduate School of Natural Sci.& Tech., Kanazawa Univ.

‡Faculty of Technology., Kanazawa Univ.

2-40-20 Kodatsuno, Kanazawa 920, Japan

Tel (0762)61-2101(372) Fax (0762)61-2509

E-mail: nakayamahaspnn1.ec.t.kanazawa-u.ac.jp

Abstract

This paper presents a new configuration for noise cancellation based on a combined fast adaptive algorithm. Two transversal adaptive filters F_n and F_f , adjusted by the NLMS and the FTF algorithms respectively, are used. F_n is used for providing the cancelling output. F_f is used for two purposes. First, setting a near optimum tap-weight vector for F_n in the initialization period and whenever the noise path has a sudden or fast change. Second, stopping adjustment of F_n when signal comes. The new configuration demonstrates the following advantages. First, it can solve the inconsistency between fast convergence rate and small residual error. Second, it can quickly track a varying noise path, even when noise is colored. Third, cancellation performance is independent of correlation between signal and noise. The validity of the presented configuration is confirmed through computer simulation. Good cancellation performances are obtained when signal is a speech corrupted by a white noise, a colored noise and another speech signal. Simulation results also confirm that the presented configuration can quickly track the change of the noise path.

1 Introduction

Noise cancellation is very important in communication, especially in mobile communication and teleconferencing systems. The objectives of these applications are to reduce noise level, increase safety and intelligibility. So far, The NLMS algorithm is one of the most popular algorithm used for noise cancellation [1]. The slow convergence rate is, however, a main demerit of the NLMS algorithm, especially when noise source is colored. Another problem is that, when signal and noise are highly correlated, noise cancellation performance will be

degraded. Though some efforts have been made [2], efficient algorithms for noise cancellation are still remained as a problem.

In our recent study, a combined fast adaptive filter algorithm has been proposed [3]. In the combined method, one adaptive filter and two complementary algorithms are used. The FTF algorithm, with periodic reinitialization, can provide fast convergence and fast tracking when the unknown system suffer from a quick change. The degraded performance caused by the discontinuities in the steady state operation is compensated by using the NLMS algorithm. The improved performance in system identification has been shown in [3][4]. However, the structure of using only one adaptive filter is not suitable for the noise cancellation problem, since adjustment of the tap weights during signal period will cause a large error.

In this paper, a new configuration based on the combined algorithm is presented which attempts to solve the above mentioned problems. The essence of the new method is to avoid adjusting the tap weights during the signal period. This goal is realized by using two adaptive filters. A main filter F_n , adjusted only in the non-signal period by the NLMS algorithm, is used for providing the cancelling output. An auxiliary filter F_f , adjusted by the FTF algorithm, is used for two purposes. First, setting a near optimum tap-weight vector for F_n in the initialization period and whenever the noise path has a sudden or fast change. Second, stopping adjustment of F_n when signal comes.

The validity of the new configuration is confirmed through computer simulation. Good cancellation performances are obtained when signal is a speech corrupted by a white noise, a colored noise and another speech signal. Simulation results also confirm that the new configuration can quickly track the change of the noise path.

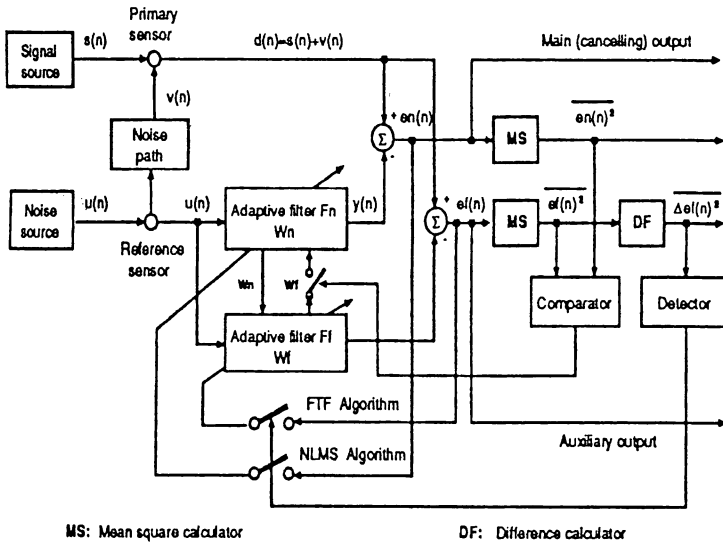

Figure 1: New configuration

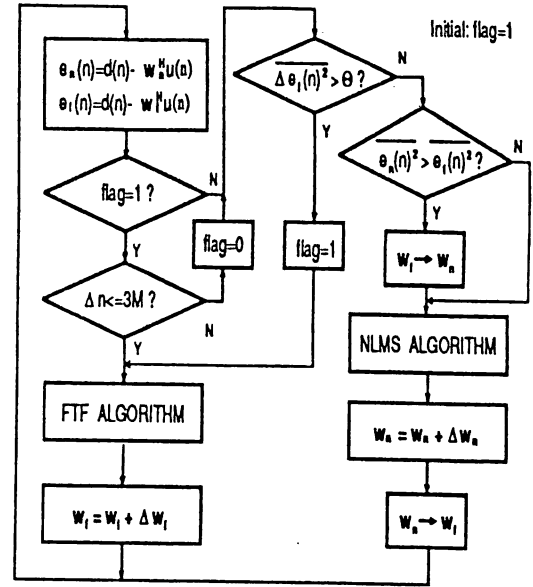

Figure 3: Flow chart

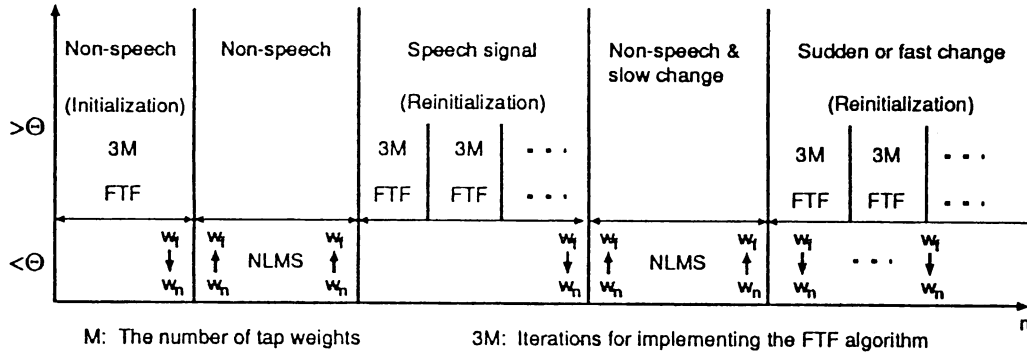

Figure 2: Timing of operation

2 The New Configuration

2.1 Principle

As shown in Fig.1, The adaptive canceler based on the new configuration consists of a detector, a comparator, a main adaptive filter F_n adjusted by the NLMS algorithm and an auxiliary adaptive filter F_f adjusted by the FTF algorithm. F_n and F_f are implemented in a parallel form with only one set of the tap weights is adjusted at a time. Switching between the two algorithms is controlled by the detector which is used for detecting the difference of the mean square error $\overline{\Delta e_f(n)^2}$. If $\overline{\Delta e_f(n)^2}$ exceeds a threshold Θ , then the FTF algorithm is selected. Otherwise, the NLMS algorithm is selected. The tap weights between the two adaptive filters are transferable. w_n are transferred to w_f whenever the NLMS is implemented, where w_n and w_f denote the tap weights of F_n and F_f , respectively. However, w_f are transferred to w_n only when the following two conditions are satisfied: (1)

$$\overline{\Delta e_f(n)^2} < \Theta, \text{ and } (2) \overline{e_f(n)^2} < \overline{e_n(n)^2}.$$

Based on the configuration shown in Fig.1, we can draw the timing of operation as shown in Fig.2. In the initialization period, the FTF algorithm is always used for achieving a fast convergence rate. When $\overline{\Delta e_f(n)^2} < \Theta$ after converging, w_f is transferred to w_n , and the NLMS algorithm is implemented. When a speech signal appears and causes $\overline{\Delta e_f(n)^2} > \Theta$, the FTF algorithm is implemented and the adjustment of w_n is stopped. Since $\overline{\Delta e_f(n)^2}$ caused by the speech signal is usually large, the implementation of the FTF algorithm will be continued until the coming of the next non-speech period. Then again $\overline{\Delta e_f(n)^2} < \Theta$ and the NLMS algorithm is selected. If the noise path suffer from a change during the speech period, w_f will converge to some new optimum values. So we have $\overline{e_f(n)^2} < \overline{e_n(n)^2}$, and w_f are transferred to w_n . If no change occurs, w_n will be remained. When the noise path has a slow change during the

non-speech period, the NLMS algorithm is capable of tracking this change. When the noise path has a sudden or fast change, fast tracking can be achieved by periodically implementing the FTF algorithm [4]. The results of \mathbf{w}_f will be transferred to \mathbf{w}_n whenever the above mentioned two conditions are satisfied.

The whole process is shown by a flow chart in Fig.3.

2.2 Feature

The above analysis reveals some important features in the new method. First, we note that the implementation of the FTF algorithm is within about 3M iterations. Keeping the FTF algorithm stable within this interval is relatively simple. Thus, some important advantages of the FTF over the NLMS, such as fast convergence rate and fast tracking, can be utilized.

Second, for a same step size, the residual error in the new configuration becomes very small compared with the conventional method. This can be explained as follows.

The step size in the NLMS algorithm is

$$\mu_{nlms}(n) = \frac{\tilde{\mu}}{\|\mathbf{u}(n)\|} \quad (1)$$

where $\|\mathbf{u}(n)\|$ is the Euclidean norm of the tap-input vector $\mathbf{u}(n)$, and $\tilde{\mu}$ is an adaptation constant. The mean square residual error ξ can be calculated as [1]

$$\xi = E[\epsilon_\infty^2] = \frac{\mu \sum_{i=1}^M \lambda_i}{2 - \mu \sum_{i=1}^M \lambda_i} \sigma_s^2 \quad (2)$$

where $\sum_{i=1}^M \lambda_i = \text{tr}(\mathbf{R}) = \text{tr}(E[\mathbf{u}(n)\mathbf{u}^H(n)]) = E[\text{tr}(\mathbf{u}(n)\mathbf{u}^H(n))] = E[\|\mathbf{u}(n)\|^2]$, and $\sigma_s^2 = E[s^2]$ is the signal power. The statistical performance of μ in the NLMS algorithm is

$$\mu = E[\mu_{nlms}(n)] = \frac{\tilde{\mu}}{E[\|\mathbf{u}(n)\|^2]} \quad (3)$$

So we get

$$\xi = E[\epsilon_\infty^2] = \frac{\tilde{\mu}}{2 - \tilde{\mu}} \sigma_s^2 \quad (4)$$

In the new method, the NLMS algorithm is implemented only in the non-speech period so that

$$\sigma_s^2 \approx 0 \quad (5)$$

Therefore, ξ becomes very small. In another word, the output signal-to-noise ratio (SNR) can be greatly improved.

Another feature is that the convergence performance is less sensitive to the eigenvalue spread

of the noise source. This should not be surprising since the FTF algorithm is essentially the same as the RLS algorithm.

Finally, the new method is independent of the correlation between signal and noise sources. In the noise cancellation problem, we recall that uncorrelation between signal and noise sources is one of the basic assumptions. Based on this assumption, the mean square error (MSE) of the canceler output can be written as [1]

$$\begin{aligned} E[\epsilon^2] &= E[s^2] + 2E[s(v-y)] + E[(v-y)^2] \\ &\approx E[s^2] + E[(v-y)^2] \end{aligned} \quad (6)$$

Since $E[s^2]$ is a constant, minimizing the total power $E[\epsilon^2]$ is equivalent to maximizing the output SNR. However, when signal is highly correlated with noise, then the term $2E[s(v-y)]$ in Eq.(6) will not be zero, which results in a degraded performance. In the new method, the adjustment of the adaptive filter F_n in speech period is avoided. So we have

$$E[\epsilon^2] \approx E[(v-y)^2] \quad (7)$$

This means that the minimum MSE solution is always achievable.

2.3 Computational requirement

The increase in the computational cost by using the new method is an extra M computations for the auxiliary filter. M denotes the number of tap weights. For one iteration, $8M$ computations are required when the FTF algorithm is used and $4M$ computations are required when the NLMS algorithm is used.

3 Simulation

3.1 Conditions of the simulation

Simulation results for noise cancellation in speech are presented in this section to demonstrate the validity of the proposed method. The simulations are divided into two cases. In the first case, we suppose the speech signal corrupted by (1) white noise, (2) colored noise, and (3) another speech. In the second case, we discuss the change of the noise path.

The speech signal used for simulation consists of a segment of a male voice, sampled at 10KHz as shown in Fig.4. The background noise is mixed with the signal after passing through a noise path, which is assumed to be a second-order IIR filter.

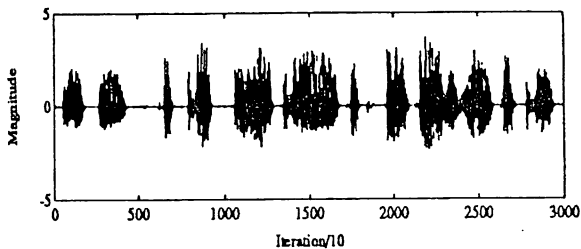

Figure 4: Speech signal used for simulation

The transfer function of the IIR filter can be written as

$$H(z) = \frac{1}{1 - 2r_p \cos(\theta)z^{-1} + r_p^2 z^{-2}} \quad (8)$$

In the simulations, we choose $r_p = 0.5$ and $\theta = \frac{\pi}{4}$. The number of tap weights is 20.

The other parameters are chosen as follows

- FTF algorithm: $\lambda = 0.99$ and $\delta = 5$. A trade-off for choosing λ and δ was discussed in [4].
- NLMS algorithm: $\tilde{\mu} = 0.02$. From Eq.(4), the final misadjustment is

$$\mathcal{M} = \frac{E[\epsilon_\infty^2]}{\sigma_s^2} = \frac{\tilde{\mu}}{2 - \tilde{\mu}} \approx 1\% \quad (9)$$

- Threshold Θ : $\Theta = KL$, where K is a positive constant which represents the speed of change of the signal or noise path, and L is the number of samples used for averaging the MSE. Choice of an appropriate K depends on practical application. In the simulations, we choose $K = 0.02$ and $L = 50$ so that $\Theta = 1$.

3.2 Simulation results and discussions

3.2.1 Change of the background noise

Three properties are investigated in this simulation. First, improved SNR after cancellation. Second, sensitivity to the eigenvalue spread of the noise source. Finally, sensitivity to the correlation between signal and noise sources.

A workstation noise is used as a colored noise. The eigenvalue spread of this noise is about 100. When the background noise is another speech signal, 50% speech power and 50% white noise power are mixed as the noise source.

The simulation results are shown in Fig.5, 6 and 7. The improved SNR is shown in Table 1. The results by using the NLMS algorithm and its

improved form for noise cancellation are shown in [2] and [5]. From these results, we make the following observations

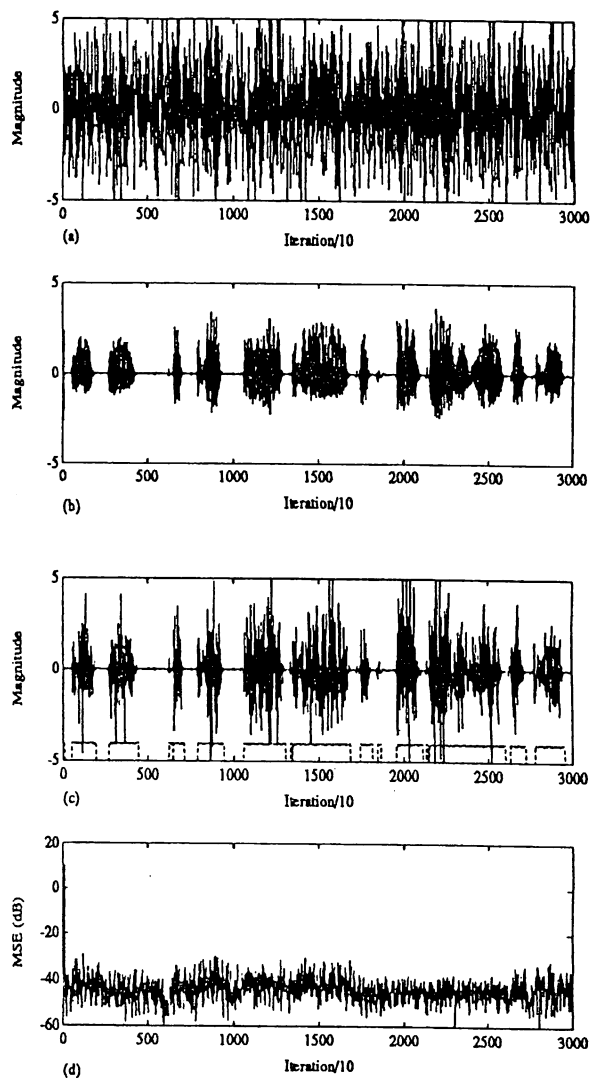

Figure 5: Speech corrupted by white noise (a) Speech before cancellation, (b) Speech after cancellation (main output), (c) Auxiliary output (solid line) and interval of implementing the FTF algorithm (dashed line) and (d) Residual MSE

Table 1 Improved SNR

| Noise source | Before cancellation | After cancellation |
|----------------|---------------------|--------------------|
| White noise | -10dB | 44dB |
| Colored noise | -10dB | 42dB |
| Another speech | -3dB | 41dB |

- Whenever the speech signal appears, the FTF algorithm is selected and the adjustment of the tap weights in the NLMS algorithm is stopped (see Fig.7(c)). Therefore, the SNR after can-

cellation is greatly improved compared with the NLMS algorithm.

- The same fast convergence rate is obtained with colored background noise, which demonstrate the insensitivity of the new method to the eigenvalue spread of the noise source.
- When the noise is another speech which is highly correlated with the signal, the new method still provides a good performance.
- The new configuration is readily applicable to adaptive echo canceler. The echo cancellation can be considered as a special example of the noise cancellation, in which the background noise is an echo which is, in fact, another speech signal.

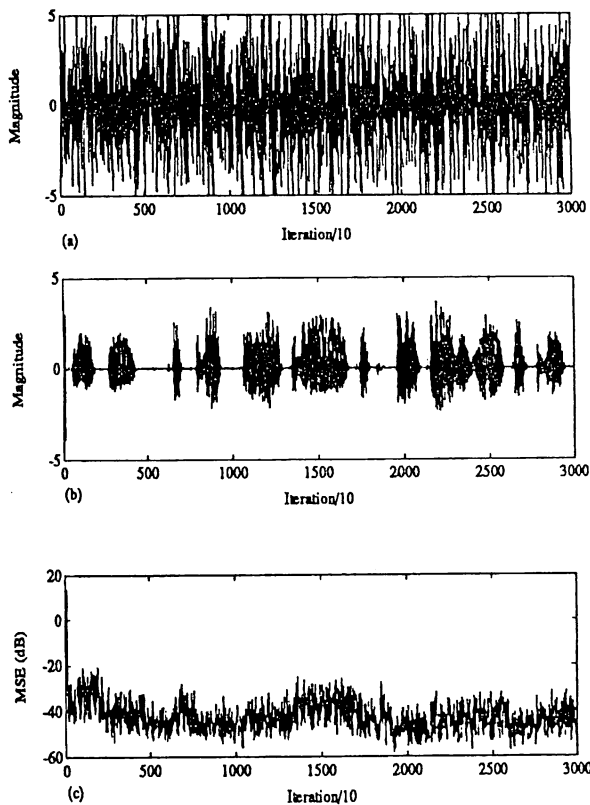

Figure 6: Speech corrupted by colored noise (a) Speech before cancellation, (b) Speech after cancellation (main output) and (c) Residual MSE

3.2.2 Change of the noise path

In this simulation, we study the tracking performance of the new method when the noise path suffer from a sudden, a slow and a fast changes.

The change of the noise path is realized by changing the phase of pole θ in Eq.(8) as shown in

Fig.8.

The simulation results are shown in Fig.9. From these results, we can see that

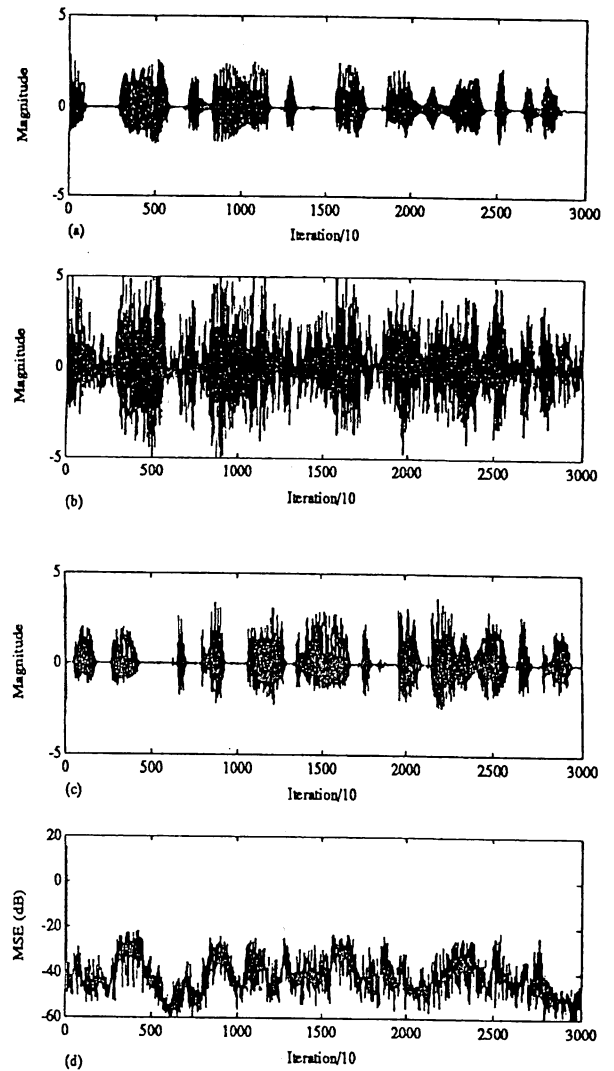

Figure 7: Speech corrupted by another speech (a) Another speech signal, (b) Speech before cancellation, (c) Speech after cancellation (main output) and (d) Residual MSE

- When the noise path has a slow change, the NLMS algorithm gives a good tracking performance. As mentioned above, for a required output SNR, we can choose a relatively large step size since the noise power contained in the non-speech period is far smaller than the signal power.
- When a sudden change of the noise path occurs in the non-speech period, the new method achieves a very fast convergence rate. When the speech signal appears, the convergence

is delayed until the coming of the next non-speech period (see Fig.9 (c) and (d)). This is because w_f adjusted in the FTF algorithm will not be transferred to w_n in the speech period.

- When the noise path has a fast change, fast tracking is achieved by reciprocally adjusting F_f and F_n .

4 Conclusion

We have presented a new configuration based on the combined adaptive algorithm. Advantages, which make the new method superior to previous works in the area of noise cancellation, are that a fast convergence rate, a fast tracking speed and a small residual error are achieved with a relatively modest computation load. Furthermore, simulations demonstrate that these desirable performances are not affected by the increase of the eigenvalue spread of the noise source, the high correlation between signal and noise as well as the change of the noise path.

Acknowledgements

The authors would like to thank Professor Funada for helpful suggestions. We are grateful to the students in our laboratory for discussions and assistances.

References

- [1] B.Widrow and D.Stearns, *Adaptive Signal Processing*, Printice-Hall, 1985.
- [2] A.Sugiyama et al., "A fast convergence algorithm for adaptive FIR filters," *Proc. ICASSP*, Glasgow, Scotland, pp.892-895, 1989.
- [3] Y.Wang and K.Nakayama, "An automatic switching method for a combined adaptive filter algorithm," *Proc. JTC-CSCC'93*, Nara, Japan, vol.1, pp.426-431, July 1993.
- [4] Y.Wang and K.Nakayama, "A combined fast adaptive filter algorithm with an automatic switching method," to be published on *IEICE Trans*.
- [5] A.Yapi, Z.Ma, and K.Nakayama, "Analysis of NLMS noise canceller performance based on correlation between signal and noise," Technical report of IEICE, DSP 92-94, pp.79-86, Questions (1993-01).

Questions (1993-01).

1. 0 on 4/2
2. when large the algorithm is there any instability

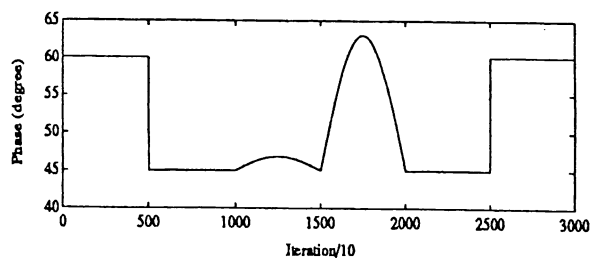

Figure 8: Change of the phase of pole in the noise path

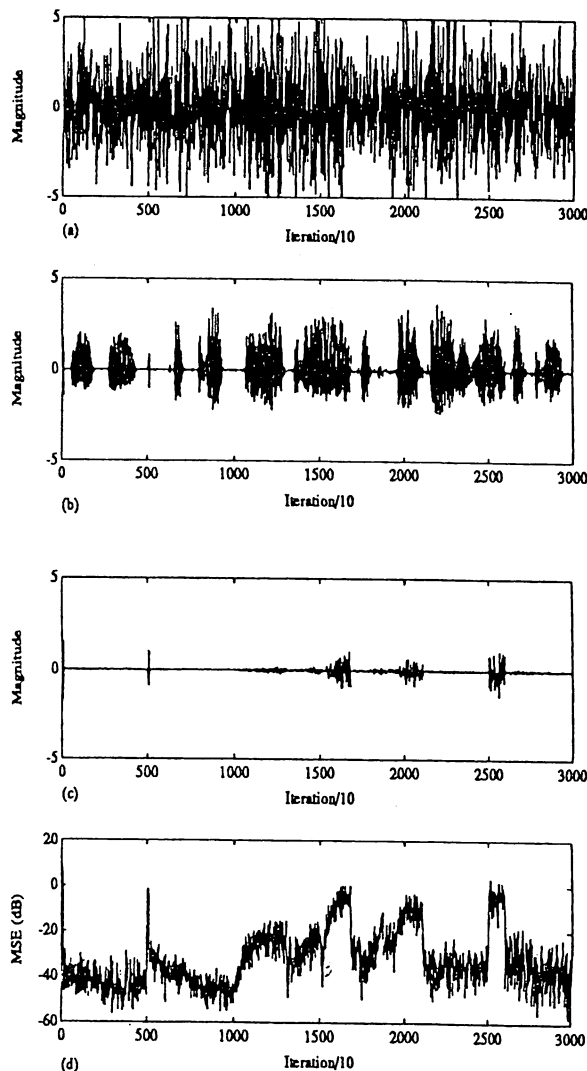

Figure 9: Simulation results when the noise path changes (a) Speech signal before cancellation, (b) Speech signal after cancellation (main output), (c) Noise after cancellation and (d) Residual MSE